

C

USER'S MANUAL

L

V1.0

DVD + - R/RW DUAL DRIVE

A

S

S

I

C

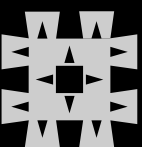
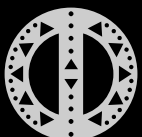

ENO
PIKA

CERTIFICATIONS AND COMPLIANCE WITH EUROPEAN COMMUNITY STANDARDS

PikaOne declares that this device has undergone control tests and has been declared compliant with the restrictions laid down for information technology equipment through European standard EN55022 relating to radio frequency emissions. Standard EN55022 is in accordance with regulation CISPR22, published by the International Committee on Radio Interference. The CE label applied to this product testifies that declaration of compliance with the current European directives mentioned below has been carried out:

- Directive 73/23/EEC, relating to low voltage
- Directive 89/336/EEC EMC, EMC directive (standards for electromagnetic compatibility)

NOTICE OF COMPLIANCE WITH THE STANDARDS OF THE DEPARTMENT OF COMMUNICATIONS OF CANADA

This digital device satisfies all the requirements of Canadian regulations relating to devices liable to cause radio electric interference.

NOTICE OF COMPLIANCE WITH THE STANDARDS OF THE FEDERAL COMMUNICATIONS COMMISSION

This equipment has undergone control tests, and has been declared compliant with the restrictions laid down for class B digital devices, through section 15 of FCC regulations. These restrictions are intended to ensure reasonable protection from unwanted interference when this device is functioning in a commercial environment. This equipment produces, uses and emits radio frequency radiation, and, in the event of installation or use that does not comply with the instructions provided in this manual, can cause unwanted interference with radio reception. Use of this equipment in a residential environment risks causing harmful interference, a problem that the user must rectify at their own expense. This peripheral complies with provisions 15 of the FCC regulations. Use of the equipment is subject to the following two conditions: (1) this device must not cause harmful interference; and (2) this peripheral must accept any interference received, including that which is liable to result in poor operation.

DANGER INVISIBLE LASER RADIATION WHEN OPEN AVOID DIRECT EXPOSURE TO BEAM



REGISTERED NAMES AND TRADEMARKS

All registered names and trademarks cited in this document are protected by copyright and belong to their respective owners. Unless otherwise stated, the names of companies, products, persons and information used in the examples are fictional. Any resemblance to existing names is fortuitous.

POTENTIAL MODIFICATIONS

The instructions and specifications appearing in this manual are for information only and may be changed without prior notice by PikaOne. This document has been put together with the utmost care, with the aim of providing you with reliable information. However, PikaOne cannot be held responsible for consequences related to any potential errors or omissions in the documentation.

PikaOne reserves the right to alter this manual or to make improvements to the design of the product, without any restriction or obligation to inform users of them.

COPYRIGHT STATEMENT

It is a criminal offence, under applicable copyright laws, to make unauthorised copies of copyright-protected material, including computer programs, films, broadcasts and sound recordings. This equipment should not be used for such purposes.

© Copyright PikaOne 2003.

All rights reserved. Any reproduction, even partial, of this manual, in whatever form, without written authorization from PikaOne is strictly prohibited and is a violation of Copyright.



INTRODUCTION	5
SYSTEM REQUIREMENTS	5
PACKAGE CONTENTS	5
INSTALLATION	6
HOST INTERFACE CONNECTIONS	6
HARDWARE INSTALLATION	7
DRIVER INSTALLATION	8
Windows Environment	8
SOFTWARE PACKAGE	8
Installation Under Windows Environment	8
CONNECTION & OPERATION	9
FRONT PANEL	9
REAR VIEW	10
DVD REGION CODING	11
REGION PLAYBACK CONTROL MANAGEMENT	11
REGION CODES	11
About This Drive	11
TECHNICAL DATA	12
APPENDIX	13



Welcome to a multimedia world of ReWritable technology with DVD burning capabilities. This multiformat recordable drive presents you more backup choices other than acting as a CD-R/RW drive and as a DVD-ROM reader. The drive supports DVD Forum's DVD-R/RW standard as well as the one of DVD+RW Alliance's DVD+R/+RW enabling excellent compatibility, simple, quick recording of both CD/DVD formats, huge capacity storage, and theater-quality playback.

The bundled package of mastering software offers the creation fun of video, photos, and music editing in addition to basic data backup. You can record up to 4.7 GB, 3 hours of TV shows or movies with high-quality MPEG2 video/AC-3 sound effect, and even more appealing, author your own DVD movies – from capture to editing and burning.

Handy, easy to use with rich function, this DVD±R/RW Writer is an ideal model to enjoy the fascinating digital entertainment on your desktop and here are some more important features:

- 4X DVD+/-R, 2X DVD+/-RW Write/Rewrite speed, 12X DVD-ROM Read speed
- 40X CD-R, 24X CD-RW Write/Rewrite speed, 40X CD-ROM Read speed
- Adopts "MTKSuperLink" to prevent Buffer Underrun errors for CD & DVD writing
- Supports writing modes of TAO, DAO, SAO and packet writing for CD-R/RW, Random Access Write, Sequential Write for DVD+/-R, DVD+/-RW
- Compatible with most existing DVD-ROM drives and DVD video players
- Bundled with an extensive software package

SYSTEM REQUIREMENTS

For IBM compatible PCs, the system requirements recommended are as follows:

- Pentium III, 600MHz or above with at least 128MB of memory
- Fast and sufficient hard disk space (minimum 650MB for installation) and 10GB disk space to create DVD
- IDE host interface supporting ATAPI MMC command
- Operating system: Microsoft Windows 98SE/ME/2000/XP

PACKAGE CONTENTS

- 1 DVD±R/RW Writer (this drive)
- 1 Audio cable
- 1 Power DVD software disc
- 1 Nero CD/DVD software disc
- 1 bag (4pcs of screws)
- 1 Media DVD+R



HOST INTERFACE CONNECTIONS

Most current mainboards have two IDE ports (primary and secondary), which can connect two IDE cables. Two IDE cables allow you to connect up to four devices, but it is recommended that you separate IDE ports for your hard drive and this writer. This will ensure that your hard drive's performance and speed won't be affected by having the writer on the same cable.

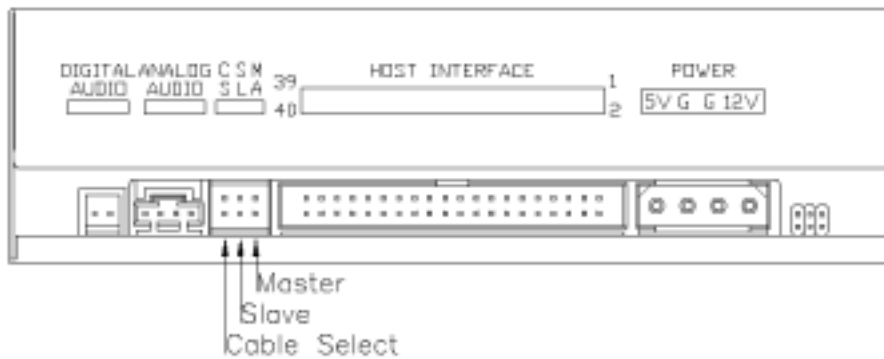

If you connect only one device on the cable, you can set the jumper as "MASTER" or "SLAVE". If you connect two devices (e.g. CD-ROM & CD-RW) on the same cable, set different jumpers for each device (CD-ROM as "MASTER", CD-RW as "SLAVE", and vice versa.) The same rule applies to the connection of having your hard disk and another device on the same cable.

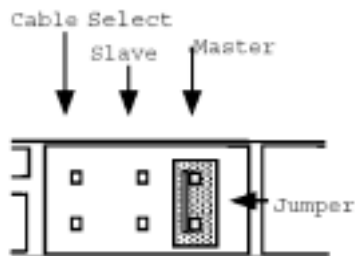

HARDWARE INSTALLATION

1. Turn off the power to the computer system.
 2. Disconnect all cables from the back of your computer, and then remove the cover from the computer.
 3. Insert the writer into one of the vacant 5.25" drive bays and secure it with screws to your PC.
- In order to prevent interference between the writer and the computer, please mount the writer using all four mounting screws.
4. Connect the 40-pin IDE cable from one of the IDE ports on the mainboard to the 40-pin connector of your writer. Also, connect the power supply cable to the back of the writer.

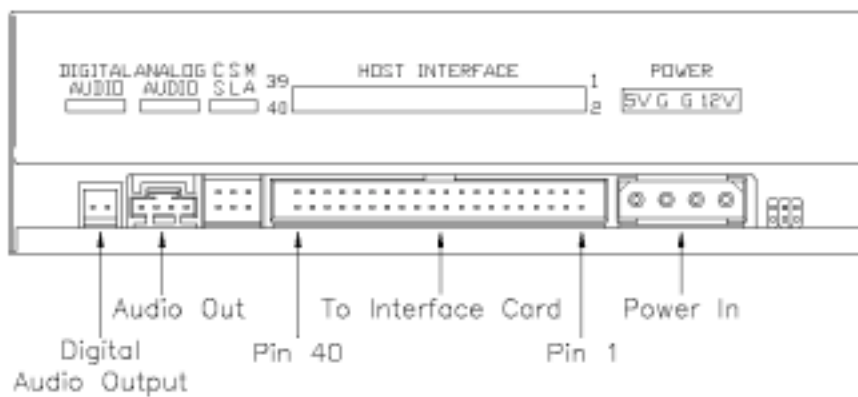

Make sure to align and connect the red-edge of the IDE Cable to Pin 1 on the drive.

5. If you have a sound card that can be connected to this writer, you can connect the drive (as Audio-out) and the sound card (as Audio-in) with a 4-pin audio cable.

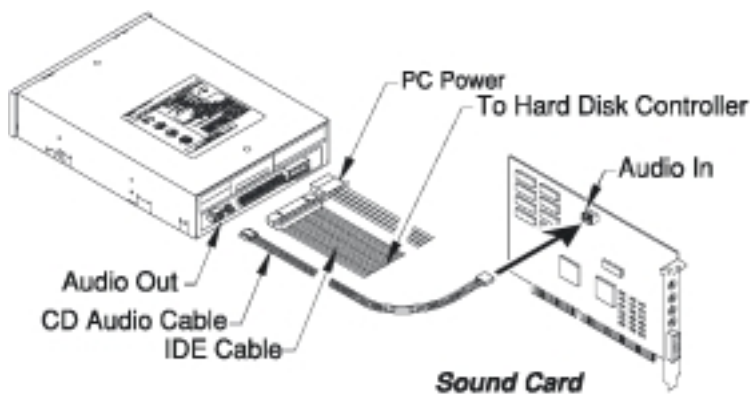

If your mainboard is integrated with built-in sound system, plug the 4-pin audio cable into the CD-IN connector on the mainboard as Audio-in.

6. Re-attach the cover of your computer, and reconnect the power cord.





WINDOWS ENVIRONMENT

This DVD±R/RW Writer is a Plug & Play device and there is no need to install driver. Windows 98SE/ME/2000/XP can automatically detect the drive and load the appropriate driver.

SOFTWARE PACKAGE

The bundled package combines software for

- 1) DVD/CD recording
- 2) DVDs/VCDs authoring
- 3) Packet Writing
- 4) DVD playback, which gives you the complete solution for making audio/data CDs/DVDs of different formats, editing video and authoring DVD movies.

The user-friendly interface simplifies the recording process and guides you through the creation in an easy and innovative way. No matter you are a novice or an experienced user; this is your best recording tools with the writer.

INSTALLATION UNDER WINDOWS ENVIRONMENT

1. Insert the application CD and the installation program will run automatically. Then follow the on-screen procedures.

Or

2. Run:\setup.exe on the application CD.

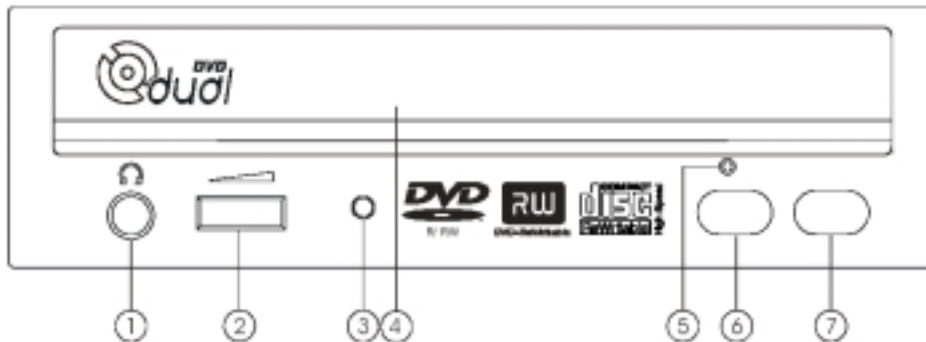

1. Headphone Plug

By plugging in the headphone jack here, you can listen to an audio CD (CD-DA disc) directly playing from the writer.

2. Headphone Volume Control

This knob adjusts the audio output level. Turn the wheel to the right/left for the volume of your headphone.

3. LED Indicator (dual color)

Flashes "green" while verifying or reading a disc.

Flashes "amber" while writing discs.

4. Disc Tray

Place the disc in the tray here, and then press the Open/Close button or lightly push the tray to close it.

5. Emergency Eject Hole

If the Open/Close button doesn't work properly and the disc tray can't be opened, you can insert a paper clip or a small rod into this hole for manual ejection.

Please make sure to power off the system before you do that.

6. Play/Skip button

Press this button to play tracks or skip to next track during the playing state.

7. Open/Close button

This button opens and closes the disc tray. If the tray is closed, pressing the button will eject it. If the drive is playing an audio disc, pressing this button will stop it.

NOTE: The front panel is subject to change without notice.



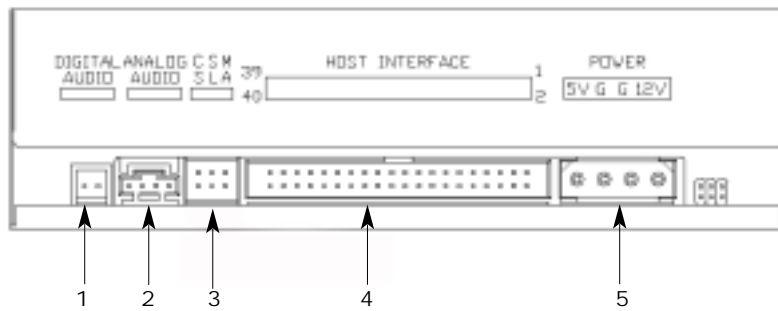

1. Digital Audio Output Connector

If your sound card has a digital audio IEC958 format connector, you can connect it to this digital audio output connector with a 2-pin audio cable.

2. Analog Audio Output Connector

This connector allows you to connect the drive to your sound card with a 4-pin audio cable.

3. Device Configuration Jumper

Set the jumper to Master, Slave or Cable Select according to your system configuration.

4. IDE Interface Connector

Plug one end of the 40-pin IDE cable here to join the 40-pin IDE connector on the motherboard.

The red-edge of the IDE cable must be connected to Pin 1 of each connector.

5. Power Supply Connector

By plugging the computer's power supply cable here, you can connect the drive and your computer system.



REGION PLAYBACK CONTROL MANAGEMENT

All DVD Video Playback systems have "Region Playback Control" (RPC) which is required by Hollywood movie industry and defined by DVD Forum. You can only play DVD-Video discs with the same region code as your DVD-Video Playback system.

As for DVD-ROM drives, one kind of the DVD-Video Playback system, there are 2 types:

RPC Phase 1 (as RPC1): RPC1 drives do not have built-in hardware support for region management. DVD-ROM drives of this kind don't play a part in controlling the playback region. It solely depends on the decoder.

RPC Phase 2 (as RPC2): RPC2 drives maintain the region change count information in hardware, and in general, the region code of such drives can be changed up to 5 times by end users under some software decoder. (e.g. PowerDVD)

REGION CODES

Region 1: Canada, U.S.

Region 2: Japan, Europe, South Africa, and Middle East, Egypt

Region 3: Southeast Asia and East Asia

Region 4: Australia, New Zealand, Pacific Islands, Central America, Mexico, South America, and the Caribbean

Region 5: Eastern Europe, Indian subcontinent, Africa, North Korea, and Mongolia

Region 6: China

ABOUT THIS DRIVE

This DVD±R/RW Writer is also a RPC2 DVD-ROM drive and the first region code will depend on the DVD title you play. You are allowed to modify the region code 5 times (including the initial one). After the fifth alteration, the region code will be locked and only those DVD titles of the same region code could be played afterwards, so set the code carefully.



Interface	E-IDE/ATAPI
Disc Data Capacity	DVD+/-R, DVD+/-RW: Single layer 4.7GB CD-R/RW: 74min/650MB, 80min/700MB
Media supported for Writing	DVD+R, DVD-R, DVD+RW, DVD-RW, CD-R, CD-RW
Writing Formats	DVD+/-R, DVD+/-RW: DVD-ROM, DVD-Video CD: CD-DA, CD-ROM, CD-ROM XA, CD-Extra, CD-I, Mixed-Mode CD, Video CD, Photo CD, CD-Text, Bootable CD, Multi-Session
Writing modes	DVD+/-R, DVD+/-RW: Random Access Write, Sequential Write CD-R/RW: TAO, DAO, SAO, Multi-session, Incremental Packet Writing
Writing Speed	DVD+/-R: 1X, 2X, 4X DVD+/-RW: 1X, 2X CD-R: 16X, 24X, 32X, 40X CD-RW: 4X, 10X, 16X, 24X
Reading Compatibility	CD Audio, CD-Extra, CD-ROM/XA, CD-I, Photo CD, Video CD, CD-Text, DVD-ROM, DVD+/-R, DVD+/-RW
Reading Speed	DVD+/-R, DVD+/-RW: max. 6X CD-R: max. 40X, CD-RW: max.32X CD-ROM: max. 40X, DVD-ROM: max. 12X
Data Transfer Rate	CD • Read CD-ROM/CD-R: 6000KB/sec (up to 40X) CD-RW: 4800KB/sec (up to 32X) CD • Write CD-R: 6000KB/sec (up to 40X) CD-RW: 3600KB/sec (up to 24X) DVD • Read DVD-ROM: 16224KB/sec (up to 12X) DVD • Write DVD+/-R: 5408KB/sec (up to 4X) DVD+/-RW: 2704KB/sec (up to 2X)
Access time	DVD: 130ms (12X) CD: 130ms (40X)
Data buffer	2MB
Disc loading	Tray (motorized)
Dimensions (WxHxD)	148.6 x 41.8 x 193.3 mm
Weight	1 kg
Mounting Method	Horizontal
Temperature	Operating 5°C to 45°C • Non-operating -20°C to 60°C
Humidity	Operating 8% ~ 80%RH • Non-operating 5% ~ 95%RH



DVD FORUM

The DVD Forum is an international organization made up of companies using or manufacturing digital versatile disc (DVD)-related products. The Forum was created in 1995 when ten companies (Hitachi, Matsushita, Mitsubishi, Philips, Pioneer, Sony, Thomson Multimedia, Time Warner, Toshiba Corporation, and Victor) joined for the common purpose of promoting DVD worldwide and establishing standardized formats of each DVD application for the marketplace.

DVD+RW ALLIANCE

The DVD+RW Alliance is a voluntary group of industry-leading personal computing manufacturers, optical storage and electronics manufacturers including Dell, Hewlett-Packard Company, MCC/Verbatim, Philips Electronics, Ricoh Company Ltd., Sony Corporation, Thomson multimedia and Yamaha Corporation. The group seeks to develop and promote a universally compatible, rewritable DVD format to enable true convergence between personal computing and consumer electronics products.

DVD FLLC (FORMAT, LOGO, LICENSING, CORPORATION)

DVD Format/Logo Licensing Corp (DVD FLLC) was established in 2000 to handle issuing of the DVD specifications, granting licenses to manufacturers and policing the use of the DVD logos. All manufacturers of hardware, discs and related DVD products must be licensed and first products verified to ensure that all players will play all discs. The correct logos must be used for the appropriate products in the appropriate way.



DVD FORMATS

DVD Video

Popular format for viewing movies and other visual entertainment with high quality MPEG2 video & digital surround sound. Enables multi-language, multi-subtitling and other advanced user features.

DVD Audio

This audio-only storage format doubles the fidelity of sound effect comparing with a standard CD as well as longer playing times, copy protection and anti-piracy measures...etc.

DVD-ROM (DVD Read Only Memory)

Read-only DVD discs used for storing data and interactive sequences as well as audio and video.

DVD-R (DVD Recordable)

A write-once format used to master DVD Video and DVD-ROM discs. Good for archiving data and recording home movie discs.

DVD-RW (DVD ReWritable)

The DVD Forum's format with a read-write capacity of 4.7GB per side. It can be re-written up to 1000 times. Suitable for backups, DVRs, and movies.

DVD+R (DVD Recordable)

A write-once format. Good for archiving data and recording DVD movies.

DVD+RW (DVD ReWritable)

The DVD+RW Alliance's fast, 1000-times-rewritable format. Excellent for backups, good for movies, real-time video recording & random data burning

DVD-RAM (DVD Random Access Memory)

The DVD Forum's 100,000-times-rewritable format. Suitable for backups and DVRs.

REFERENCE

For more related information about the organizations and formats definition of DVD, please refer to the following web sites:

<http://www.dvdrw.com>

<http://www.dvdforum.org>

<http://www.licensing.philips.com>

<http://www.disctronics.co.uk>

<http://www.dvdfllc.co.jp>

PIKAONE TELEPHONE SUPPORT NUMBERS

England	44 (0) 207 949 0192
Germany	49 (0) 696 698 4715
Spain	34 (0) 9 13 49 65 05
France	33 (0) 3 87 17 01 33
Italy	39 (0) 2 48 27 11 44

